

MJE243 - NPN, MJE253 - PNP



ON Semiconductor®

<http://onsemi.com>

Complementary Silicon Power Plastic Transistors

These devices are designed for low power audio amplifier and low-current, high-speed switching applications.

Features

- High Collector–Emitter Sustaining Voltage –
 $V_{CE(sus)} = 100 \text{ Vdc (Min)}$
- High DC Current Gain @ $I_C = 200 \text{ mAdc}$
 $h_{FE} = 40 - 200$
 $= 40 - 120$
- Low Collector–Emitter Saturation Voltage –
 $V_{CE(sat)} = 0.3 \text{ Vdc (Max) @ } I_C = 500 \text{ mAdc}$
- High Current Gain Bandwidth Product –
 $f_T = 40 \text{ MHz (Min) @ } I_C = 100 \text{ mAdc}$
- Annular Construction for Low Leakages
 $I_{CBO} = 100 \text{ nAdc (Max) @ Rated } V_{CB}$
- Pb–Free Packages are Available*

**4.0 AMPERES
POWER TRANSISTORS
COMPLEMENTARY SILICON
100 VOLTS, 15 WATTS**

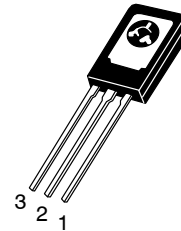

TO-225
CASE 77
STYLE 1

MAXIMUM RATINGS

Rating	Symbol	Value	Unit
Collector–Emitter Voltage	V_{CEO}	100	Vdc
Collector–Base Voltage	V_{CB}	100	Vdc
Emitter–Base Voltage	V_{EB}	7.0	Vdc
Collector Current – Continuous – Peak	I_C	4.0 8.0	Adc
Base Current	I_B	10	Adc
Total Power Dissipation @ $T_C = 25^\circ\text{C}$ Derate above 25°C	P_D	15 120	W mW/ $^\circ\text{C}$
Total Power Dissipation @ $T_A = 25^\circ\text{C}$ Derate above 25°C	P_D	1.5 12	W mW/ $^\circ\text{C}$
Operating and Storage Junction Temperature Range	T_J, T_{stg}	–65 to +150	$^\circ\text{C}$

THERMAL CHARACTERISTICS

Characteristic	Symbol	Max	Unit
Thermal Resistance, Junction–to–Case	θ_{JC}	8.34	$^\circ\text{C/W}$
Thermal Resistance, Junction–to–Ambient	θ_{JA}	83.4	$^\circ\text{C/W}$

Maximum ratings are those values beyond which device damage can occur. Maximum ratings applied to the device are individual stress limit values (not normal operating conditions) and are not valid simultaneously. If these limits are exceeded, device functional operation is not implied, damage may occur and reliability may be affected.

MARKING DIAGRAM

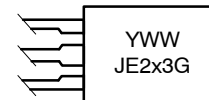

Y = Year
WW = Work Week
JE2x3 = Device Code
x = 4 or 5
G = Pb–Free Package

ORDERING INFORMATION

Device	Package	Shipping
MJE243	TO–225	500 Units/Box
MJE243G	TO–225 (Pb–Free)	500 Units/Box
MJE253	TO–225	500 Units/Box
MJE253G	TO–225 (Pb–Free)	500 Units/Box

Preferred devices are recommended choices for future use and best overall value.

*For additional information on our Pb–Free strategy and soldering details, please download the ON Semiconductor Soldering and Mounting Techniques Reference Manual, SOLDERRM/D.

MJE243 – NPN, MJE253 – PNP

ELECTRICAL CHARACTERISTICS (T_C = 25°C unless otherwise noted)

Characteristic	Symbol	Min	Max	Unit
OFF CHARACTERISTICS				
Collector–Emitter Sustaining Voltage (I _C = 10 mAdc, I _B = 0)	V _{CEO(sus)}	100	–	V
Collector Cutoff Current (V _{CB} = 100 Vdc, I _E = 0) (V _{CE} = 100 Vdc, I _E = 0, T _C = 125°C)	I _{CBO}	– –	0.1 0.1	μA mA
Emitter Cutoff Current (V _{BE} = 7.0 Vdc, I _C = 0)	I _{EBO}	–	0.1	μAdc
ON CHARACTERISTICS				
DC Current Gain (I _C = 200 mAdc, V _{CE} = 1.0 Vdc) (I _C = 1.0 Adc, V _{CE} = 1.0 Vdc)	h _{FE}	40 15	180 –	–
Collector–Emitter Saturation Voltage (I _C = 500 mAdc, I _B = 50 mAdc) (I _C = 1.0 Adc, I _B = 100 mAdc)	V _{CE(sat)}	– –	0.3 0.6	V
Base–Emitter Saturation Voltage (I _C = 2.0 Adc, I _B = 200 mAdc)	V _{BE(sat)}	–	1.8	V
Base–Emitter On Voltage (I _C = 500 mAdc, V _{CE} = 1.0 Vdc)	V _{BE(on)}	–	1.5	V
DYNAMIC CHARACTERISTICS				
Current–Gain – Bandwidth Product (I _C = 100 mAdc, V _{CE} = 10 Vdc, f _{test} = 10 MHz)	f _T	40	–	MHz
Output Capacitance (V _{CB} = 10 Vdc, I _E = 0, f = 0.1 MHz)	C _{ob}	–	50	pF

MJE243 – NPN, MJE253 – PNP

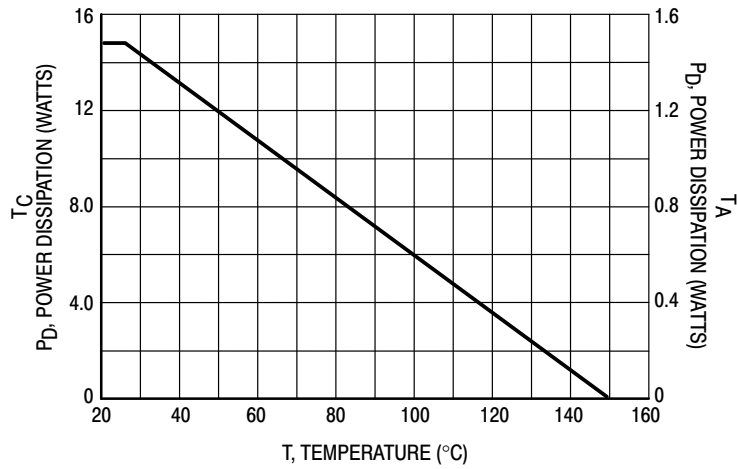
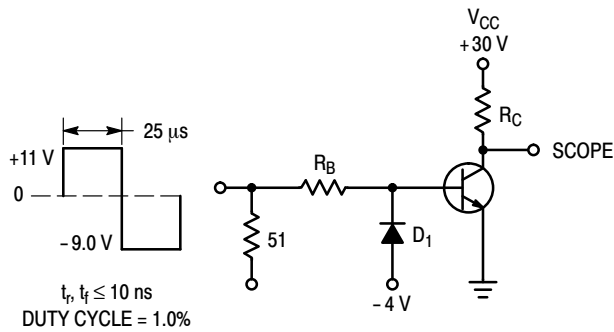

Figure 1. Power Derating



R_B and R_C VARIED TO OBTAIN DESIRED CURRENT LEVELS
 D_1 MUST BE FAST RECOVERY TYPE, e.g.:
 1N5825 USED ABOVE $I_B \approx 100$ mA
 MSD6100 USED BELOW $I_B \approx 100$ mA
 FOR PNP TEST CIRCUIT, REVERSE ALL POLARITIES

Figure 2. Switching Time Test Circuit

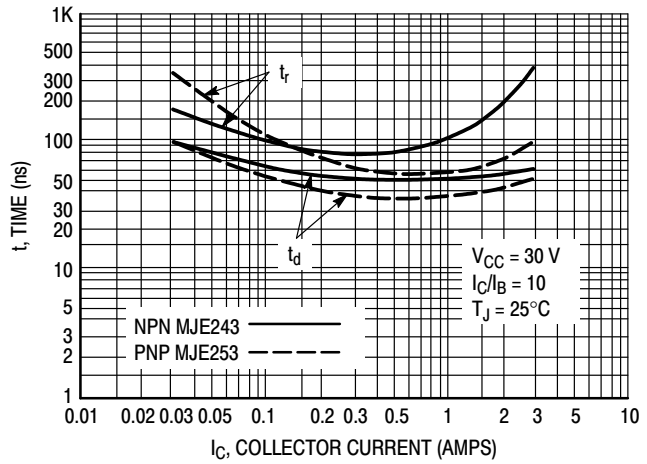

Figure 3. Turn-On Time

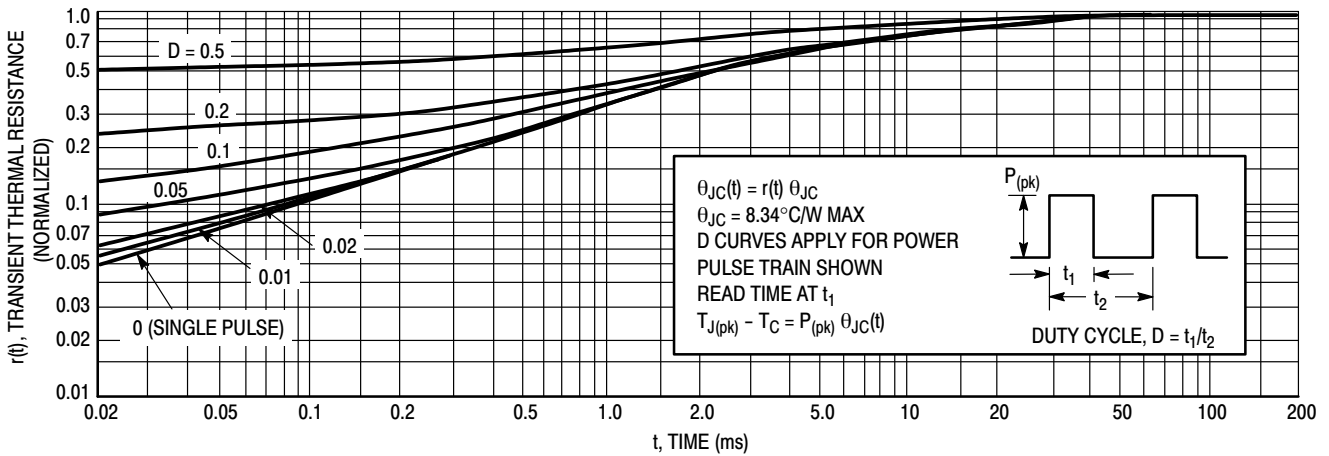

Figure 4. Thermal Response

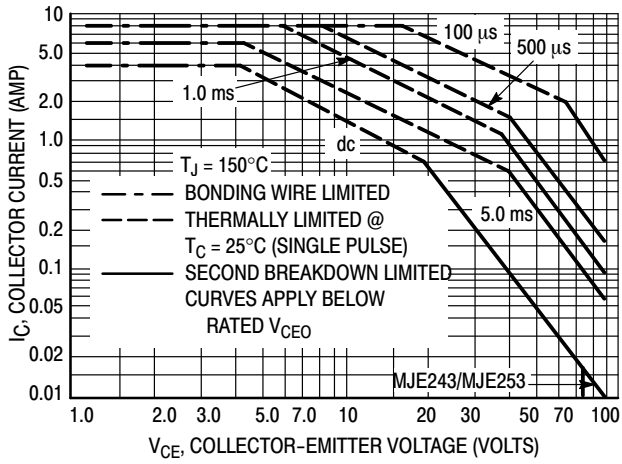

Figure 5. Active Region Safe Operating Area

There are two limitations on the power handling ability of a transistor: average junction temperature and second breakdown. Safe operating area curves indicate $I_C - V_{CE}$ limits of the transistor that must be observed for reliable operation; i.e., the transistor must not be subjected to greater dissipation than the curves indicate.

The data of Figure 5 is based on $T_{J(pk)} = 150^\circ\text{C}$; T_C is variable depending on conditions. Second breakdown pulse limits are valid for duty cycles to 10% provided $T_{J(pk)} \leq 150^\circ\text{C}$. $T_{J(pk)}$ may be calculated from the data in Figure 4. At high case temperatures, thermal limitations will reduce the power that can be handled to values less than the limitations imposed by second breakdown.

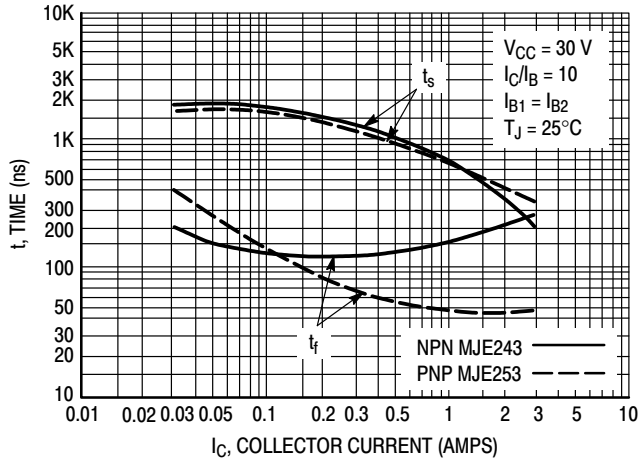

Figure 6. Turn-Off Time

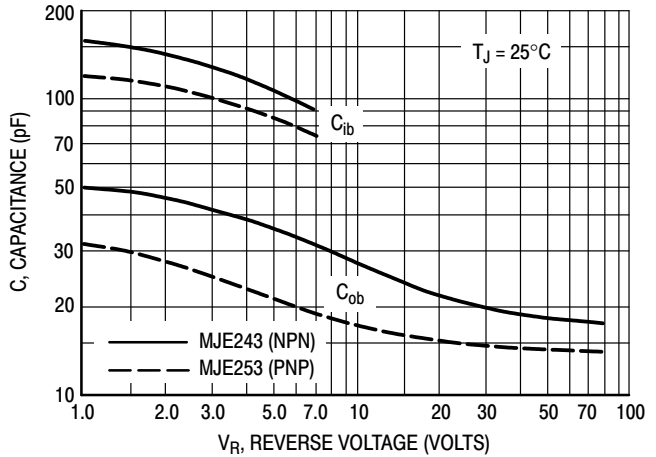

Figure 7. Capacitance

**NPN
MJE243**

**PNP
MJE253**

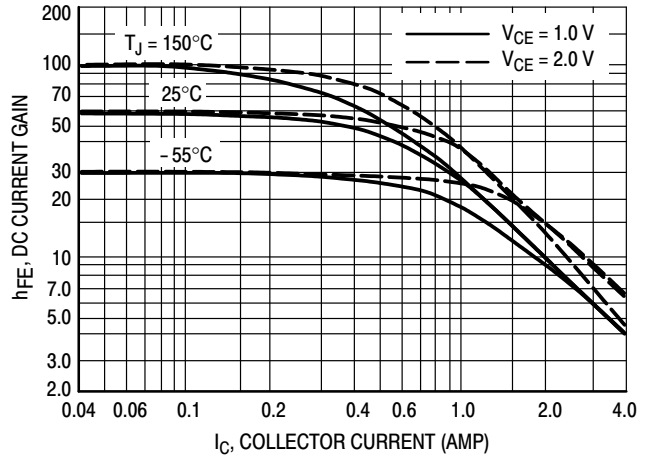
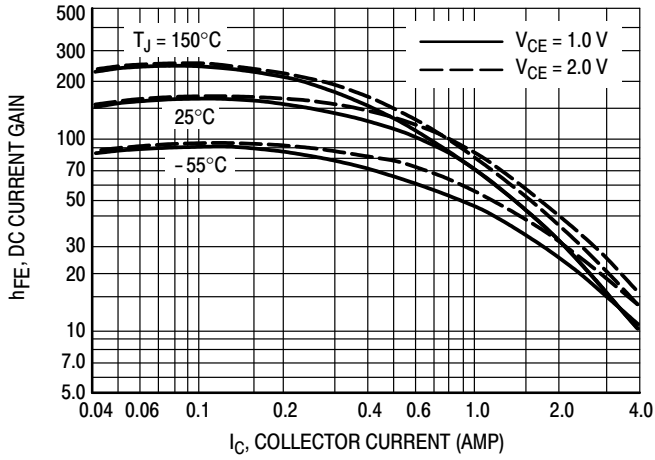

Figure 8. DC Current Gain

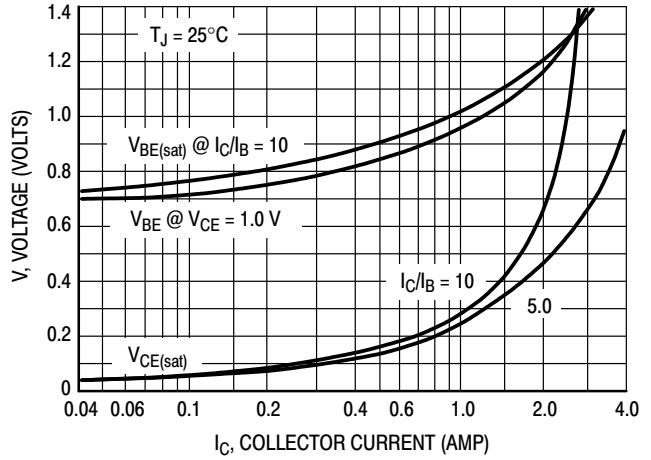
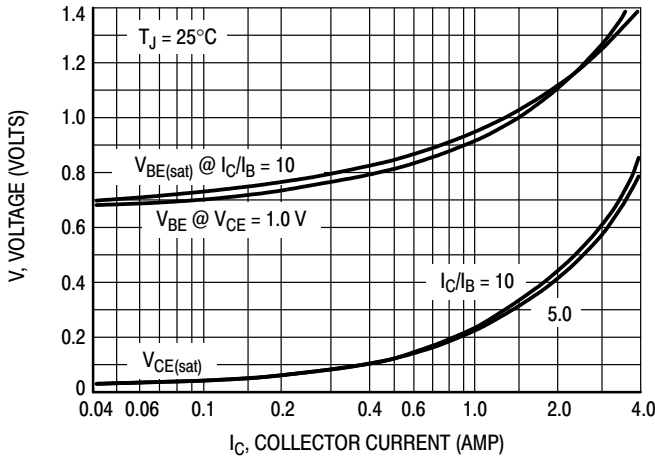

Figure 9. "On" Voltages

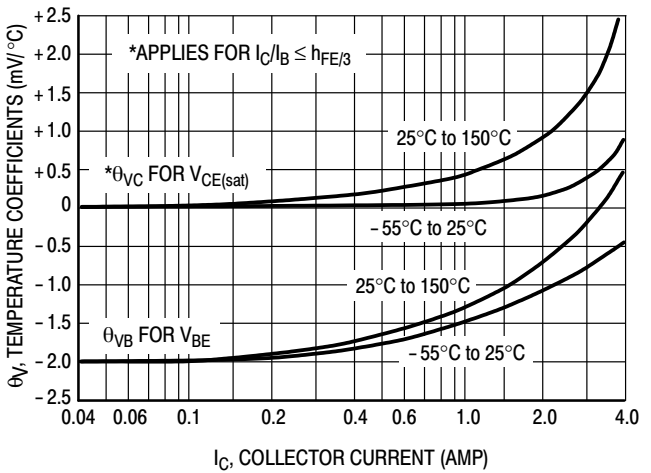
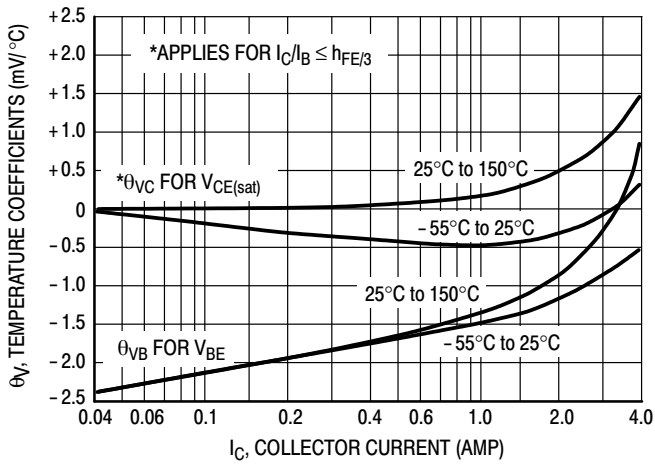
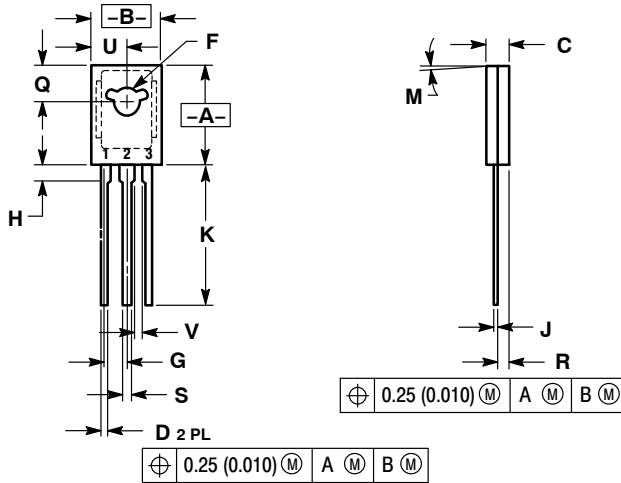

Figure 10. Temperature Coefficients

MJE243 – NPN, MJE253 – PNP

PACKAGE DIMENSIONS

TO-225
CASE 77-09
ISSUE Z



NOTES:

1. DIMENSIONING AND TOLERANCING PER ANSI Y14.5M, 1982.
2. CONTROLLING DIMENSION: INCH.
3. 077-01 THRU -08 OBSOLETE, NEW STANDARD 077-09.

DIM	INCHES		MILLIMETERS	
	MIN	MAX	MIN	MAX
A	0.425	0.435	10.80	11.04
B	0.295	0.305	7.50	7.74
C	0.095	0.105	2.42	2.66
D	0.020	0.026	0.51	0.66
F	0.115	0.130	2.93	3.30
G	0.094 BSC		2.39 BSC	
H	0.050	0.095	1.27	2.41
J	0.015	0.025	0.39	0.63
K	0.575	0.655	14.61	16.63
M	5° TYP		5° TYP	
Q	0.148	0.158	3.76	4.01
R	0.045	0.065	1.15	1.65
S	0.025	0.035	0.64	0.88
U	0.145	0.155	3.69	3.93
V	0.040	---	1.02	---

STYLE 1:

1. EMITTER
2. COLLECTOR
3. BASE

ON Semiconductor and are registered trademarks of Semiconductor Components Industries, LLC (SCILLC). SCILLC reserves the right to make changes without further notice to any products herein. SCILLC makes no warranty, representation or guarantee regarding the suitability of its products for any particular purpose, nor does SCILLC assume any liability arising out of the application or use of any product or circuit, and specifically disclaims any and all liability, including without limitation special, consequential or incidental damages. "Typical" parameters which may be provided in SCILLC data sheets and/or specifications can and do vary in different applications and actual performance may vary over time. All operating parameters, including "Typicals" must be validated for each customer application by customer's technical experts. SCILLC does not convey any license under its patent rights nor the rights of others. SCILLC products are not designed, intended, or authorized for use as components in systems intended for surgical implant into the body, or other applications intended to support or sustain life, or for any other application in which the failure of the SCILLC product could create a situation where personal injury or death may occur. Should Buyer purchase or use SCILLC products for any such unintended or unauthorized application, Buyer shall indemnify and hold SCILLC and its officers, employees, subsidiaries, affiliates, and distributors harmless against all claims, costs, damages, and expenses, and reasonable attorney fees arising out of, directly or indirectly, any claim of personal injury or death associated with such unintended or unauthorized use, even if such claim alleges that SCILLC was negligent regarding the design or manufacture of the part. SCILLC is an Equal Opportunity/Affirmative Action Employer. This literature is subject to all applicable copyright laws and is not for resale in any manner.

PUBLICATION ORDERING INFORMATION

LITERATURE FULFILLMENT:

Literature Distribution Center for ON Semiconductor
P.O. Box 5163, Denver, Colorado 80217 USA
Phone: 303-675-2175 or 800-344-3860 Toll Free USA/Canada
Fax: 303-675-2176 or 800-344-3867 Toll Free USA/Canada
Email: orderlit@onsemi.com

N. American Technical Support: 800-282-9855 Toll Free
USA/Canada
Europe, Middle East and Africa Technical Support:
Phone: 421 33 790 2910
Japan Customer Focus Center
Phone: 81-3-5773-3850

ON Semiconductor Website: www.onsemi.com

Order Literature: <http://www.onsemi.com/orderlit>

For additional information, please contact your local Sales Representative